



THE FUTURE OF ORBITAL WELDING

Innovation is our DNA



CompactOne – The royal class

ALL-IN-ONE ORBITAL SOLUTION

COMPLETE ORBITAL SOLUTION FROM A SINGLE SOURCE

CompactOne is the lightest and most compact welding system in the world.

Simple smartphone-style operation, touch panel and various help functions make it a leader in innovation in its sector.

- Intuitive operation thanks to touch panel & revolutionary software
- Connection options for residual oxygen analyzer via Bluetooth
- Various documentation management possibilities



Tools and accessories

Pipe cutters
Page 20



CWH Closed welding heads
Page 7

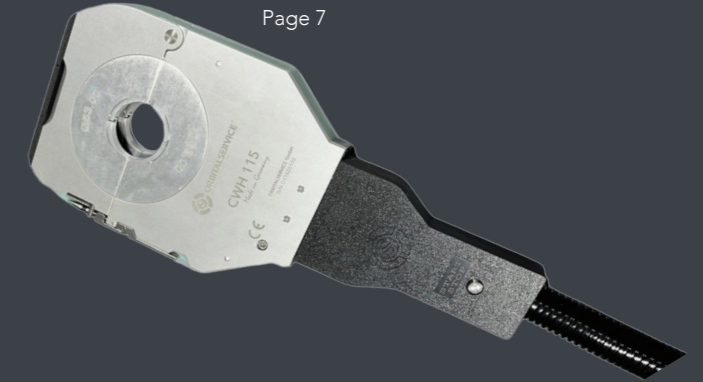

Purging gas chambers
Page 19



Oxygen analyzer PRO2 Stick
Page 14



Presentation of
the CompactOne

CompactDual – Economy with class

TWO-IN-ONE ORBITAL SOLUTION

COST-EFFECTIVE ORBITAL SOLUTION FROM A SINGLE SOURCE

CompactDual is the most cost-effective manual and orbital TIG welding equipment in the world.

Its multi-voltage power supply allows worldwide operation.

- High quality manual/orbital welding equipment with 220A DC output
- Simple operator guidance
- 250 manual welding programs can be saved
- 99 orbital welding programs with synergic function



Tools and accessories

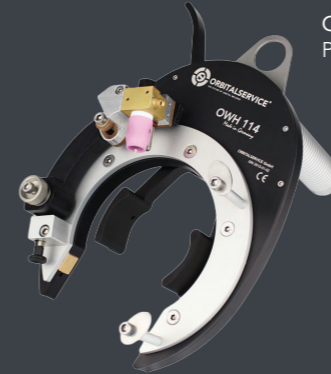

OWH Open welding heads
Page 6

Tube aligning tools
Page 21



CWF Cold wire feeder
Page 12



TR-1000 Rolling system
Page 10

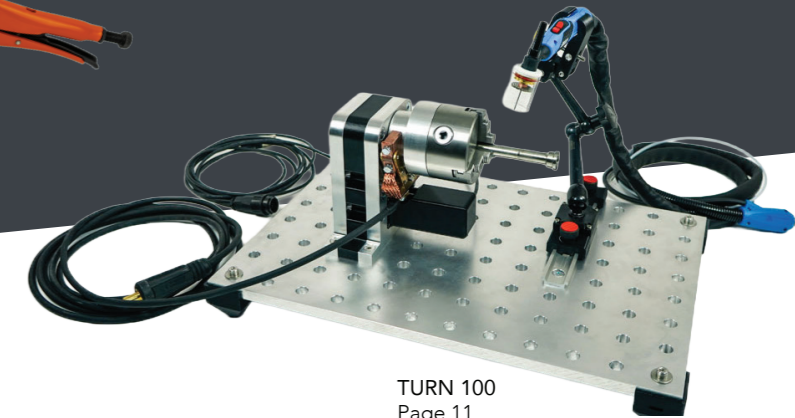

TURN 100
Page 11

OWH – Open Weld Heads

WIDE RANGE OF PRODUCTS

FOR ANY APPLICATION

With our open orbital welding heads, we cover a range of orbital welding from OD 8 mm up to OD 273 mm (0.31" - 10.75").

Exclusive is the possibility of conversion with the wire kit AVC-OSC. This allows the operator to weld pipes with very thick walls, without the need to purchase new machines and welding heads. Every orbital welding system includes all of the additional motor control cards for cold wire, AVC and OSC.

- **OWH 40** OD: 8 - 40 mm (0.31" - 1.57")
- **OWH 76** OD: 10 - 80 mm (0.39" - 3.15")
- **OWH 114** OD: 15 - 115 mm (0.59" - 4.53")
- **OWH 168** OD: 25 - 170 mm (0.98" - 6.69")
- **OWH 273** OD: 101 - 273,3 mm (3.98" - 10.75")

CWH – Closed Weld Heads

NARROWEST WELD HEADS OF ITS RANGE EXISTING ON THE MARKET

We supply a range of closed weld heads, which are the narrowest on the market within its category.

The microfitting weld head as well as the replacement and wear parts are fully compatible with the AMI 9-500 weld head. This weld head is the most used in the semiconductor industry around the world, having proved it for almost 4 decades.

A new geometry of the clamping jaws allows our own "just in time" production. This saves costs and improves delivery times.

- **CWH -5H** OD: 3 - 15,88 mm (1/8" - 5/8")
- **CWH -10H** OD: 6,35 - 24,4 mm (1/4" - 1")
- **CWH 13** OD: 3,17 - 12,7 mm (0.12" - 0.50")
- **CWH 21** OD: 3,17 - 21,3 mm (0.12" - 0.84")
- **CWH 38** OD: 3,17 - 38,1 mm (0.12" - 1.50")
- **CWH 53** OD: 6 - 53 mm (0.24" - 2.09")
- **CWH 76** OD: 6 - 76,2 mm (0.24" - 3.00")
- **CWH 115** OD: 8 - 114,3 mm (0.31" - 4.50")

CWH -5H / -10H



CWH 13

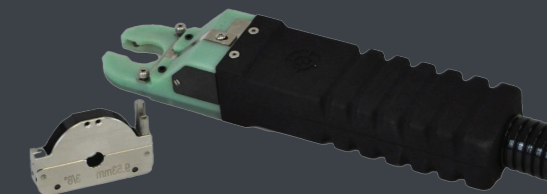

Differential pressure gauge for measuring internal pressure

UPGRADEABLE
WITH AVC/OSC



Presentation of the
Open Weld Head

TTS – Tube-to-Tube Sheet Weld Heads

SUITABLE WELD HEADS FOR EVERY PROJECT

TTS 40

Our fusion only tube-to-tube sheet weld head is small, practical & easy to use and is suitable for stainless steels, titanium and nickel-based alloys.

- Clamping mandrels, also compatible with the TTS 90 model
- Suitable for titanium applications
- Optional pneumatic clamping system

TTS 90

The tube-to-tube sheet weld head with cold wire (co-rotating) features a pneumatic clamping system. Works in overhead positions, thanks to its mandrels and powerful pneumatic clamping system.

- Maximum diameter range up to 120 mm (4.724")
- Rotating cold wire feeder
- Pneumatic clamping mandrel included

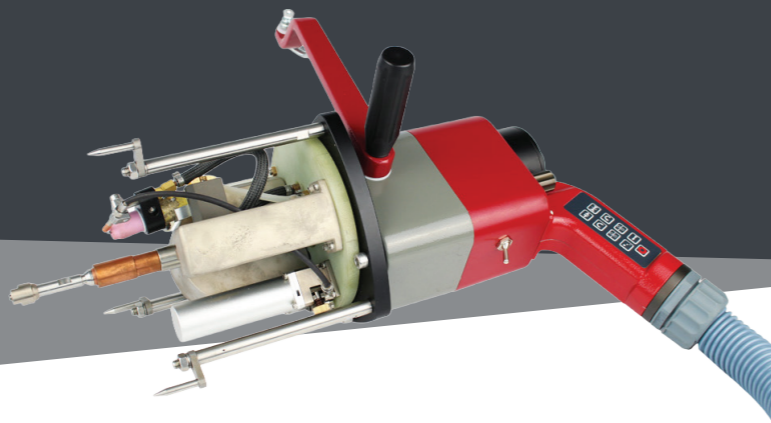

RC Mini – Remote Control

The 5" capacitive touch display allows a convenient wired or wireless smartphone-style operation.

- Intuitive operation, thanks to its touch screen and revolutionary software
- Range of up to 100 meters via Bluetooth class 1
- Wired version available
- A4 documentation in PDF available
- Bluetooth connection with optional printer or residual oxygen analyzer



RC plus+ – Remote Controls

Easy-to-use cable remote control allows the operator to change parameters during the welding process, such as currents, wire speed, arc voltage and also oscillation. In OFF mode, you can test gas and water flows, rotation, wire, AVC and OSC movements.

Wireless remote control available for more flexibility.

MORE POTENTIAL THANKS TO INCREASED MOBILITY



TR 1000 – Rolling Systems



**UPGRADEABLE
WITH AVC/OSC**

PERFECT COMMUNICATION

BETWEEN ORBITAL POWER SUPPLY AND WELD HEAD

The rolling system is a tool which allows the welding of small tubes, as well as large containers.

Furthermore, cold wire, AVC and OSC can be connected, which greatly expands the field of applications.

It is also used as a base for special welds (e. g. simultaneous welding with 2 systems at both ends of the tube). For this purpose, we have built additional pneumatic sets for displacement, clamping and centering, angular adjustment, supports, etc.

- Range from OD 20 mm to 323 mm (0.787" to 12.717")
- Other sizes (up to approx. OD 1000 mm - 39.37") on request
- Can be modularly expanded with profile kits



Welding with our
Rolling System

Turn – Turntables

VERSATILE USE

FOR WELDING OF ASSEMBLIES

With our TURN 100 and TURN 250 turntables, we offer two high quality tools to complete the range of the best-known orbital welding tools (open weld heads, closed weld heads, tube-tube sheet weld heads).

- All devices with hollow shafts
- Adaptations of the cross support, linear welding device, swing arm and angle adjustment possible



Turn 100 Turntable



TURN 100

**UPGRADEABLE
WITH AVC/OSC**

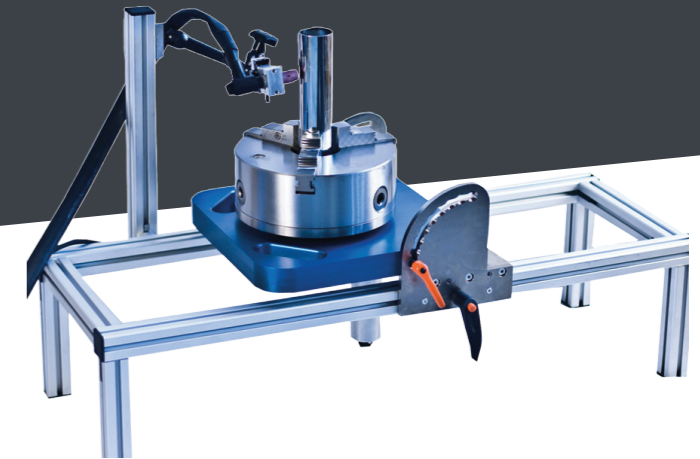

CWF – Cold Wire Feeders



STABILITY AND ROBUSTNESS IN THE FOCUS

These robust cold wire feeders are characterized by their compact dimensions. The suitcase can be closed and protects the mechanical components from dirt, oil, etc.

These devices can be connected to OWH open weld heads, rolling systems, turntables and linear units.

Available in three versions:

- **CWF 1** 1 kg- wire spool (2.2 lb)
0.6 mm and 0.8 mm wire diameters
- **CWF 5** 5 kg- wire spool (11.02 lb)
0.8 mm and 1.0 mm wire diameters
- **CWF 15** 5 and 15 kg- wire spool (33.07 lb)
0.8 mm and 1.0 mm wire diameters

TF – Pipe Facing Machines

OPTIMAL PREPARATION FOR PERFECT RESULTS

Tube beveling machines (facers) are required to achieve unions without burrs and perpendicular. The best solution for a correct preparation of tube ends are the high-quality TF 1.6 and TF 4.5 facers.

- **TF 1.6** Range: 3,17 mm to 38,1 mm (0.31" - 1.50")
110V-230V cable or battery versions
- **TF 4.5** Range: 6,0 mm to 114.3 mm (0.25" - 4.52")
110V-230V cable version

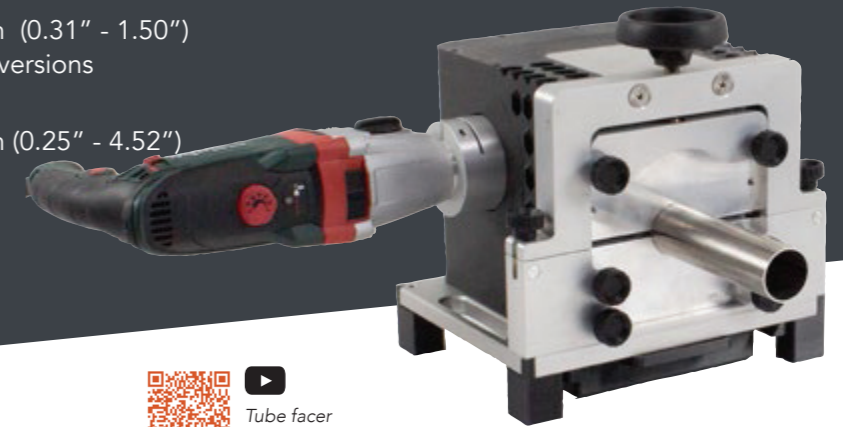
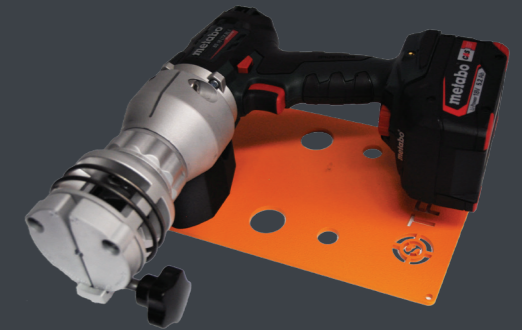

Tube facer
TF 4.5

PRO2 Stick – Oxygen Analyzer

MODERN SOLUTIONS

WITH AN UNIQUE DESIGN

One of the few instruments capable of measuring O₂ in gases containing H₂.

The innovative and modern solution among oxygen analyzers.

The PRO2 stick starts quickly by shaking the device and can be easily controlled via Bluetooth by our CompactOne power supply or RC Mini wireless controller.

Ready to measure in 5 seconds!

- Measuring range: 1000 ppm to 1 ppm
- Non sensitive to H₂, humidity or ozone
- Shake to measure mode
- Battery life: 11 hours
- Display with 180° auto rotation

- Automatically powers off after 10 minutes without measurements below 1000 ppm
- Bluetooth 100 m, class 1



Presentation of
the PRO2 Stick

PRO2 EXPERT – Oxygen Analyzer

INNOVATIVE DESIGN

ADVANCED TECHNOLOGY

Intelligent charging management and high-quality integrated components turn this device into the market leader in its sector. Equipped with a wear-proof zirconium sensor. Ready to measure in 60 seconds!

- Only dry gases measurement!
- Innovative color concept: optical and acoustic information about operating statuses
- Optical color warning of discharged battery
- Can be operated and charged via USB-C, for example with a power bank
- Battery life: > 4 hours
- Diffusion-tight FPM special gas tube



Presentation of
the PRO2 Expert

OrbiBug – Welding Carriage

HIGH-PRECISION

ORBITAL BUG FOR LARGE-DIAMETER PIPES

Range of Application:
OD 200 mm to 1,000 mm (7.874" - 39.370")

Holder for 1 kg (2.2 lb) Sigmat Wire Spool and 5kg (11.02 lb) standard spools.

Different wire diameters: 0.6 mm, 0.8 mm, 1.0 mm and 1.2 mm.

The OrbiBug is attached to a guide ring. Gears engage into the laser cutouts in order to avoid slipping.



SPECIAL APPLICATIONS? NO PROBLEM!

INDIVIDUAL SOLUTIONS

TAILORED TO YOUR REQUIREMENTS

We develop solutions, design and manufacture orbital and special welding systems. We customize our exclusive products according to the individual needs and requirements from our customers.

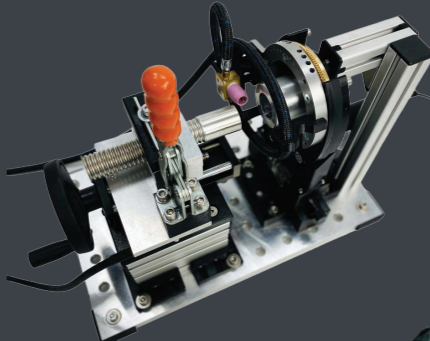

EQUIPMENT FOR CORRUGATED PIPE

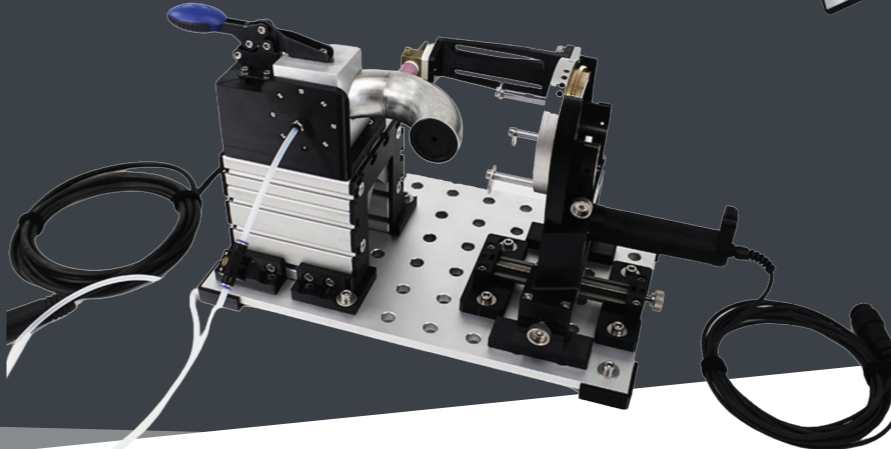

EET-50 DOUBLE ELBOW EQUIPMENT



EQUIPMENT FOR CONTAINER COVERS

TC 600 – Pipe Aligner

OPTIMAL SOLUTIONS

PATENTED

With our innovative and patented TC 600 stainless-steel pipe tensioners for TIG manual tack welding, pipes and bends can be tack welded together manually. This tensioning system is very light, practical and easy to operate.

- Allows tack welding pipes between 60 and 600 mm (2.362" - 23.622")
- For tube-to-tube joints, fittings, elbows and more
- Additional tightening connections for adjusting ovalities/tubes of different diameters (TC-611)
- Practical transport case

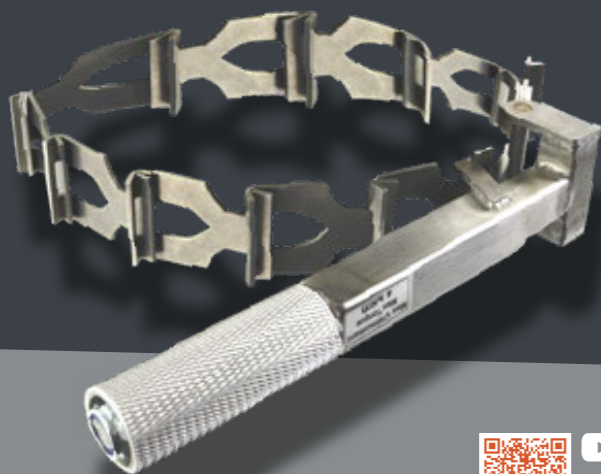

 Presentation of the TC 600



Purging gas stopper set and caps

WORLD'S FIRST !

CAPS

- For pipe OD 6 mm to 114,3 mm (0.236" - 4.50")
- For high purity applications
- Center hose connection, either with clamp wedge ring fitting (Swagelok) or plug-in coupling (Festo-SMC)



PLUG SET WITH SWIRL NOZZLES

Plugs and swirl nozzles in a compact case with transparent cover.

- For pipe OD from 9 to 110mm (0.354" - 4.331")



 Presentation of our purging plugs and nozzles

VERSATILE ACCESSORIES
FOR DIFFERENT NEEDS

Pipe cutting and bevelling

FAST, BURR-FREE & PRECISE

Compact and lightweight machines for pipes ranging from Ø 6 to 330 mm (0.236" - 12"). Our OTS series delivers burr-free, precise cutting within 0.25 mm (0.009") tolerance.

Wide Range of Applications

The OTS orbital tube saw series is the perfect solution for precise pipe preparation. Available in five models (OTS-3, OTS-4, OTS-6, OTS-8, OTS-12), each covers a specific diameter range:

- OTS-3 – Ø 6 - 80 mm (0.236" - 3.149")
- OTS-4 – Ø 12 - 120 mm (0.472" - 4.724")
- OTS-6 – Ø 16 - 171 mm (0.63" - 6.73")
- OTS-8 – Ø 55 - 228 mm (2.165" - 8.976")
- OTS-12 – Ø 140 - 330 mm (5.512" - 12.992")



 Presentation of the OTS Series

REPRODUCIBLE ELECTRODE PREPARATION

Ensures consistent, high-quality preparation of common tungsten sizes, for example 1.6, 2.4 and 3.2 mm (0.063" - 0.125").



 Presentation of the Tungsten Grinder

Tacking and aligning tools

PRECISE ALIGNMENT FOR ORBITAL WELDING

This product family combines TIG Tack Clamps, HT Tack Welding Clamps and V-Blocks for secure clamping and exact positioning of tubes, fittings and components.

TIG TACK CLAMPS

One-hand "grip pliers" with interchangeable heads from OD 6 mm to 168.3 mm (0.236" - 6.614"), gripping firmly without deformation and avoiding contamination on stainless steel tubes.

HT TACK WELDING CLAMPS (STAPLERS)

Stainless steel tack clamps with narrow jaws for MicroFit from Ø 4 mm to 19.05 mm (0.157" - 0.75") and wide jaws up to Ø 114.3 mm (4.50") for versatile orbital applications.

V-BLOCKS

Stable pipe supports that complement the clamps, ensuring precise, repeatable positioning during preparation and welding.



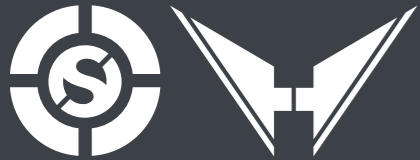

ORBITALSERVICE
GROUP

OVER 33 YEARS OF EXPERIENCE

We have 3 production sites (approx. 2,500 m²), in which we design, manufacture and assemble.

We have state-of-the-art technologies such as 3D printing and scanning, as well as the latest CNC and measuring technology available.



orbitalservice-group.com



www.heronitec-solutions.de



2

COMPANIES



>15

EMPLOYEES



3

PATENTS



>40

INTERNATIONAL
SALES PARTNERS



>120

INNOVATIVE
PROJECTS

ALWAYS A STEP AHEAD

We invest a lot of passion in new ideas in order to develop and manufacture innovative products. High affinity for new technologies and new designs in the industry set us apart.

Thanks to our vast experience, we are always one step ahead in the market with our products and we think future-oriented. Motivated by a constant exchange with our customers and technological partners we meet market needs and new potential opportunities opening up in the industry.

We develop, design and manufacture for our customers as a certified company according to international ISO 9001:2015 quality standards, thus ensuring the quality of our products and services.



Orbitalservice's
Corporate video

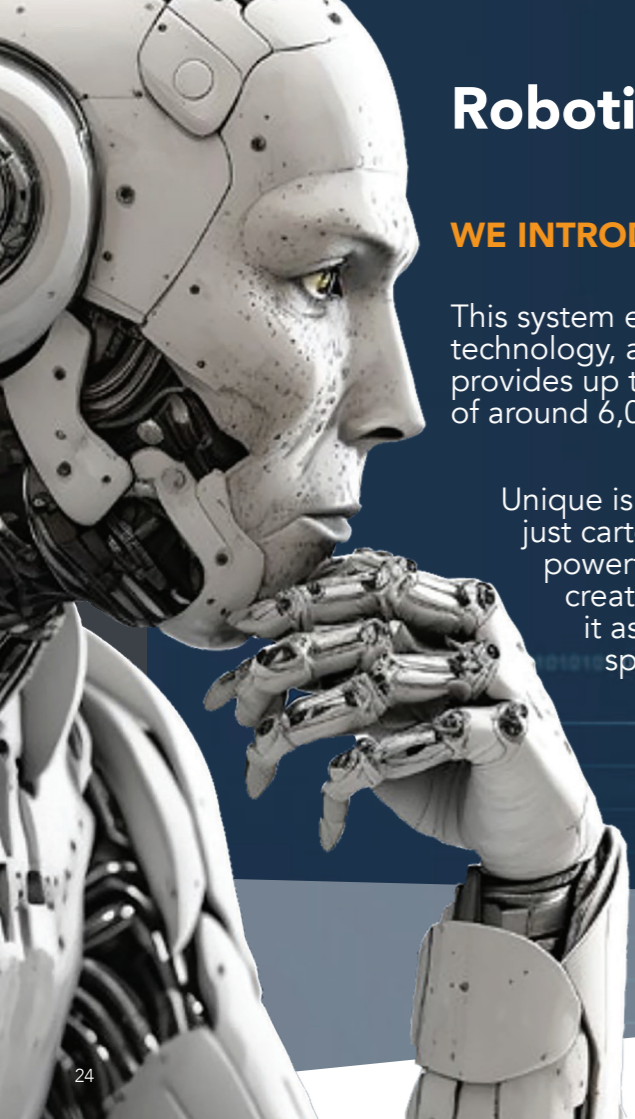

Robotic Solutions

WE INTRODUCE OUR FIRST OWN GANTRY ROBOT SYSTEM

This system extends welding capabilities beyond the limits of orbital technology, allowing even complex jobs to be completed. The robot provides up to 10 axes, and the system can be scaled to an axis length of around 6,000 mm (236.220").

Unique is the very quick calculation of the welding path (not just cartesian) if there is a CAD model. This is calculated by powerful processors. If no CAD model is available, you can create a 3D model using various optical sensors and use it as well. We have created software and hardware with AI specifically for this purpose.

The declared objective of the Orbitalservice Group is to allow every user in the market for standard industrial robots or Cobot to learn the basics of this technology in less than 30 minutes.

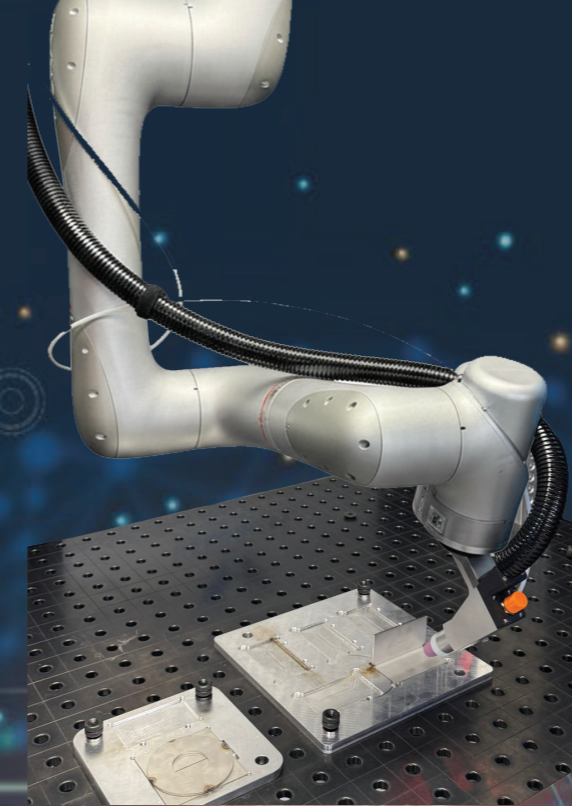

For this purpose, we have entered into a partnership with Heronitec Solutions. This company is also part of our small industrial innovation park.

Daily communication with designers and professionals allows not only quick reaction times, but also to uncover practical solutions, not yet available on the global market.



THE FUTURE OF ORBITAL WELDING, TODAY AND TOMORROW

R&D

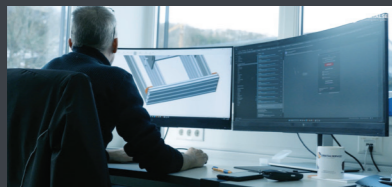

Services



Training

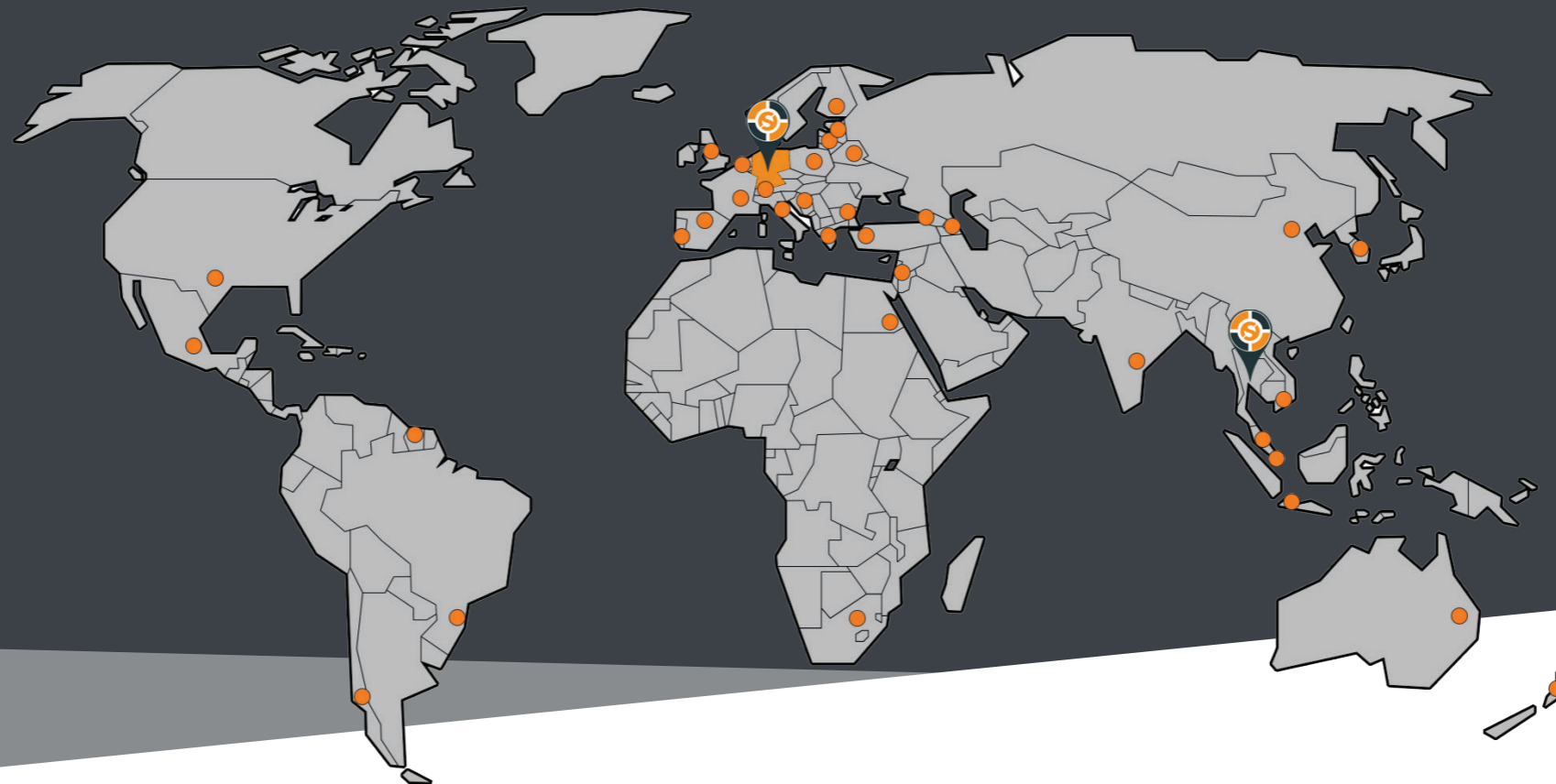
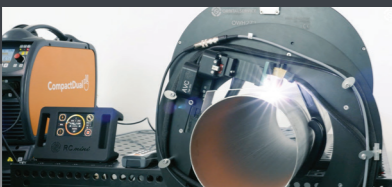

Follow.

Subscribe.

Connect.

[@orbitalservicegmbh](https://www.instagram.com/orbitalservicegmbh)

[#OrbitalserviceGmbH](https://www.facebook.com/OrbitalserviceGmbH)

[#TheFutureOfOrbitalWelding](https://www.youtube.com/hashtag/TheFutureOfOrbitalWelding)





MADE IN GERMANY

COMPETENCE CONCENTRATED IN ONE LOCATION



ORBITALSERVICE
GROUP



ORBITALSERVICE GmbH
Kreuzdelle 13 63872
Heimbuchenthal
Germany



[orbitalservice-group.com](https://www.orbitalservice-group.com)
info@orbitalservice.de



+49 6092 82294 0

